



ACUCRAFT FIREPLACE SPEC SHEET

MODEL: A-BL-16-STT
SERIES: BLAZE

DIMENSIONS

Viewing Area:	192"W x 30"H, Sealed
Dimensions:	204"W x 67 1/2"H x 30"D

FRAMING SPECIFICATIONS

A	B	C
208"	71 1/2"	30"

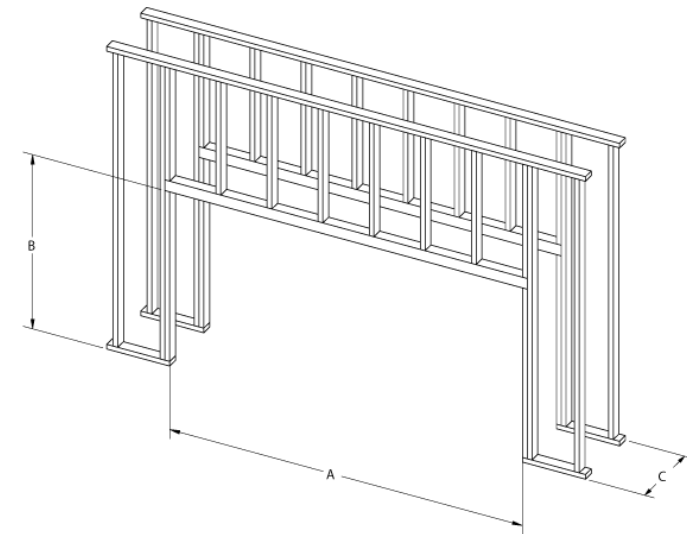
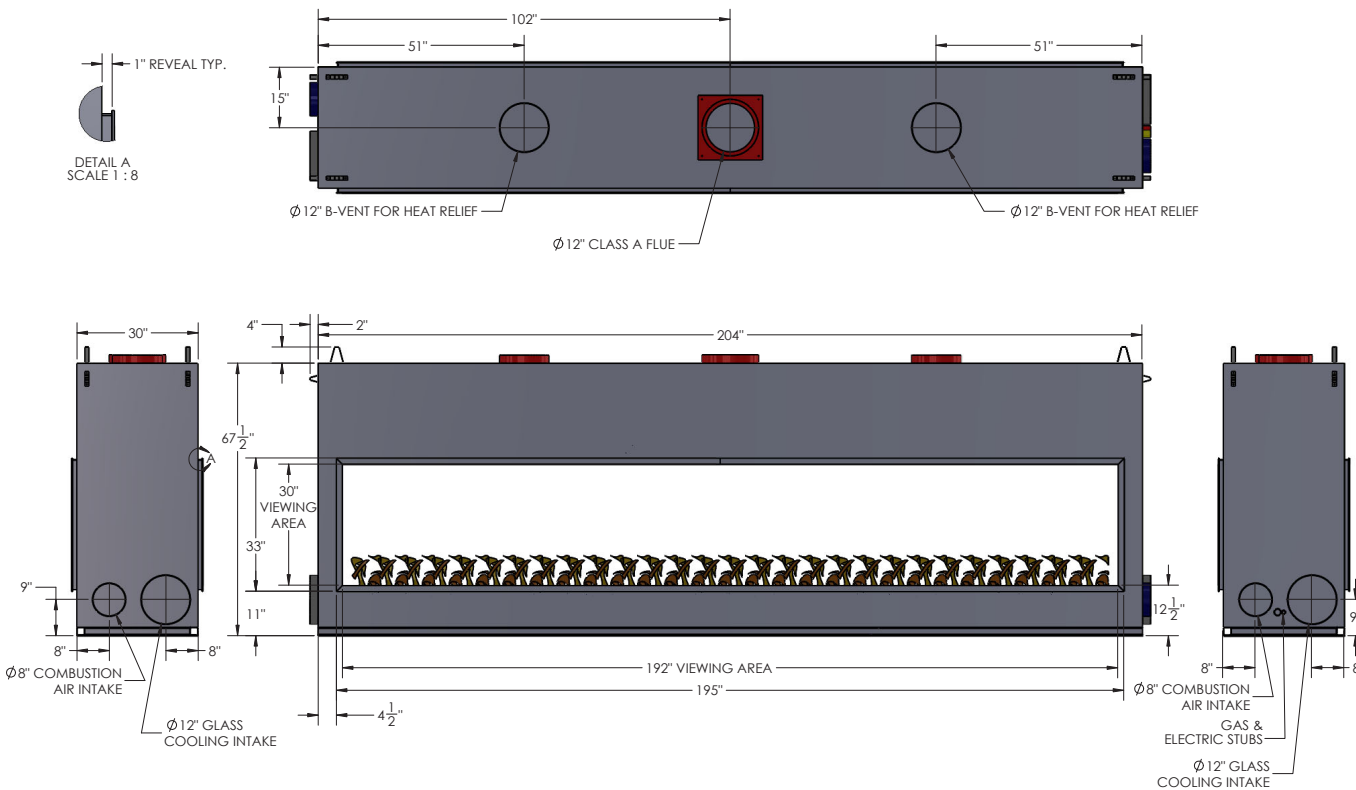

Acucraft Fireplaces
Big Lake, MN
Acucraft.com
888-317-6499
info@acucraft.com



ACUCRAFT FIREPLACE SPEC SHEET

MODEL: A-BL-16-STT
SERIES: BLAZE

DESCRIPTION

Experience The Acucraft Difference with our BLAZE Linear Gas Fireplaces.

Designed with commercial grade components and thick, 7-gauge steel, the BLAZE linear gas fireplaces fit seamlessly in restaurants, hotels and residential homes. Modern, clean & the tallest flames on the market will create the ultimate ambiance!

FEATURES & BENEFITS

- Viewing Sizes & Styles
- Tallest Flames on the Market
- 5-Year Warranty on Acucraft's Ignition System
- Lifetime Warranty on the Firebox
- Commercial Grade Components
- Rigorous Testing Including: Functionality, Safety, ANSI Z21.50 with Label
- Popular Customization Options
- Worldwide Shipping Direct to Your Job Site
- Designed & Manufactured in Minnesota, USA

SPECIFICATIONS

Viewing Area:	192"W x 30"H	BTUs/Hour:	225,000
Fireplace Dimensions:	204"W x 67 1/2"H x 30"D	Combustion Air Intake:	Dual 8"
Burner Length:	186"	Class A Flue Size:	12"
Min. Inlet Pressure:	7" W.C. NG, 11" W.C. LP	Max. Inlet Pressure:	14" W.C. NG, 14" W.C. LP
Fuel Type:	Natural Gas or Propane	Controls:	On/Off Switch
Power Venting:	Enervex RS12 (Flue), Dual Enervex RS16 (Heat Relief)	Electrical:	110V AC

Clearance to Combustibles:	2" Sides, 4" Height, 2" Depth
Testing Standards:	ANSI Z21.50
Media Options:	1/4" or 1/2" glass media, rock options, log sets
Interior Options:	Mesh, reflective panels, LED lighting
Mantel Clearances:	12" top of face/trim, 6" off sides of face/trim

Acucraft Fireplaces
Big Lake, MN
Acucraft.com
888-317-6499
info@acucraft.com